

N-Channel JFETs

Product Summary

Part Number	$V_{GS(off)}$ (V)	$r_{DS(on)}$ Max (Ω)	$I_{D(off)}$ Typ (nA)	t_{ON} Typ (ns)
U290	-4 to -10	3	0.01	14
U291	-1.5 to -4.5	7	0.01	14

Features

- Low On-Resistance: U290 $<3 \Omega$
- Fast Switching— t_{ON} : 14 ns
- High Off-Isolation: Low $I_{D(off)}$
- Low Capacitance: 20 pF
- Low Insertion Loss

Benefits

- Low Error Voltage
- High-Speed Analog Circuit Performance
- Negligible “Off-Error,” Excellent Accuracy
- Good Frequency Response
- Eliminates Additional Buffering

Applications

- Analog Switches
- Choppers
- Sample-and-Hold
- Normally “On” Switches
- Current Limiters

Description

The U290/291 are high performance JFET analog switches which offer ultra low on-resistance and fast switching. This series features the lowest on-resistance of any JFET in the industry today.

The TO-206AC (TO-52) hermetically sealed can makes this series suitable for military applications (see Military Information). For similar products in TO-226A (TO-92) packaging, see the J105/106/107 data sheet.

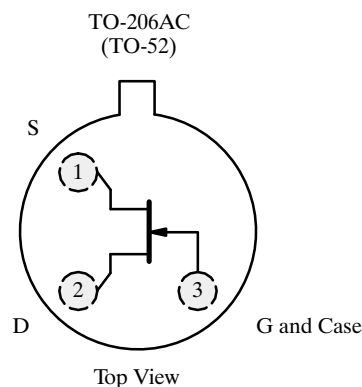

Absolute Maximum Ratings

Gate-Drain, Gate-Source Voltage	-30 V
Gate Current	100 mA
Lead Temperature ($1/16$ " from case for 10 sec.)	300°C
Storage Temperature	-65 to 200°C

Operating Junction Temperature	-55 to 150°C
Power Dissipation ^a	500 mW

Notes
a. Derate 4 mW/°C above 25°C

Specifications^a

Parameter	Symbol	Test Conditions	Typ ^b	Limits				Unit
				U290		U291		
				Min	Max	Min	Max	
Static								
Gate-Source Breakdown Voltage	$V_{(BR)GSS}$	$I_G = -1 \mu A, V_{DS} = 0 V$	-35	-30		-30		V
Gate-Source Cutoff Voltage	$V_{GS(off)}$	$V_{DS} = 15 V, I_D = 3 nA$		-4	-10	-1.5	-4.5	
Saturation Drain Current ^c	I_{DSS}	$V_{DS} = 10 V, V_{GS} = 0 V$		500		200		mA
Gate Reverse Current	I_{GSS}	$V_{GS} = -15 V, V_{DS} = 0 V$ $T_A = 125^\circ C$	-0.02		-1		-1	nA
			-0.01		-1		-1	μA
Gate Operating Current	I_G	$V_{DG} = 10 V, I_D = 25 mA$	-0.01					nA
Drain Cutoff Current	$I_{D(off)}$	$V_{DS} = 5 V, V_{GS} = -10 V$ $T_A = 125^\circ C$	0.01		1		1	
			0.005		1		1	μA
Drain-Source On-Voltage	$V_{DS(on)}$	$V_{GS} = 0 V, I_D = 10 mA$			30		70	mV
Drain-Source On-Resistance	$r_{DS(on)}$				3		7	Ω
Gate-Source Forward Voltage	$V_{GS(F)}$	$I_G = 1 mA, V_{DS} = 0 V$	0.7					V
Dynamic								
Common-Source Forward Transconductance	g_{fs}	$V_{DS} = 10 V, I_D = 25 mA$ $f = 1 kHz$	55					mS
			5					
Common-Source Output Conductance	g_{os}							
Drain-Source On-Resistance	$r_{ds(on)}$	$V_{GS} = 0 V, I_D = 0 mA, f = 1 kHz$			3		7	Ω
Common-Source Input Capacitance	C_{iss}	$V_{DS} = 0 V, V_{GS} = 0 V, f = 1 MHz$	120		160		160	pF
Common-Source Reverse Transfer Capacitance	C_{rss}	$V_{DS} = 0 V, V_{GS} = -15 V$ $f = 1 MHz$	20		30		30	
Equivalent Input Noise Voltage	\bar{e}_n	$V_{DS} = 10 V, I_D = 25 mA$ $f = 1 kHz$	3					nV/\sqrt{Hz}
Switching								
Turn-On Time	$t_{d(on)}$	$V_{DD} = 1.5 V, V_{GS(H)} = 0 V$ See Switching Circuit	6		15		15	ns
	t_r		8		20		20	
Turn-Off Time	$t_{d(off)}$		5		15		15	
	t_f		9		20		20	

Notes

- $T_A = 25^\circ C$ unless otherwise noted.
- Typical values are for DESIGN AID ONLY, not guaranteed nor subject to production testing.
- Pulse test: $PW \leq 300 \mu s$ duty cycle $\leq 3\%$.

NVA

Typical Characteristics

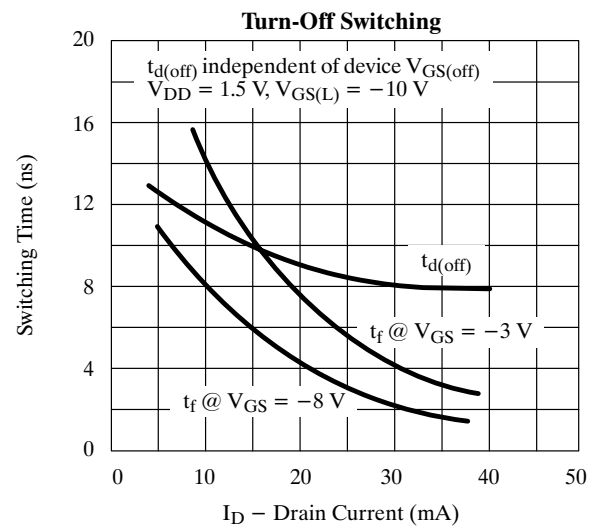
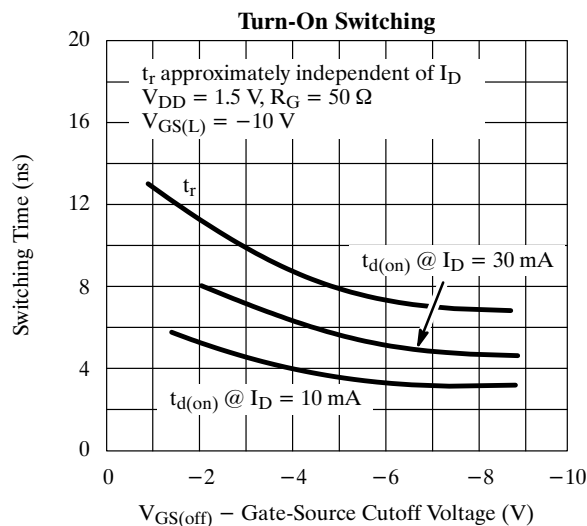
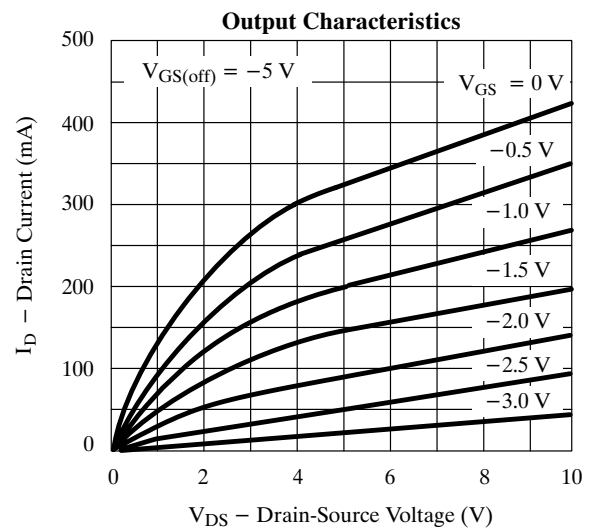
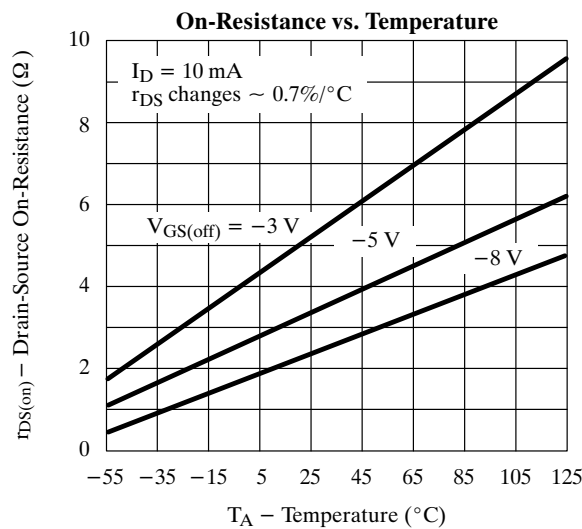
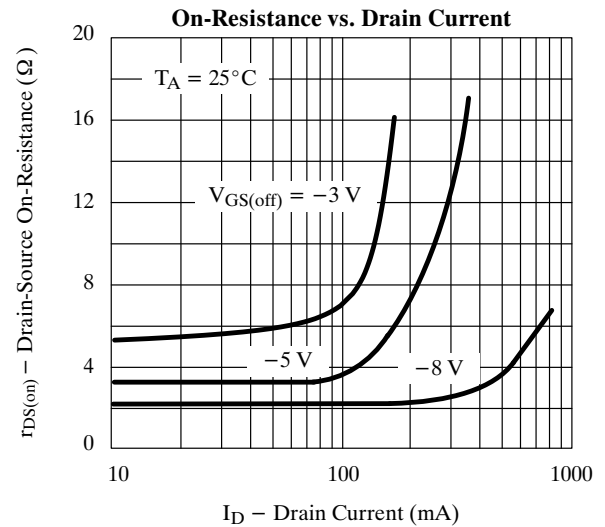
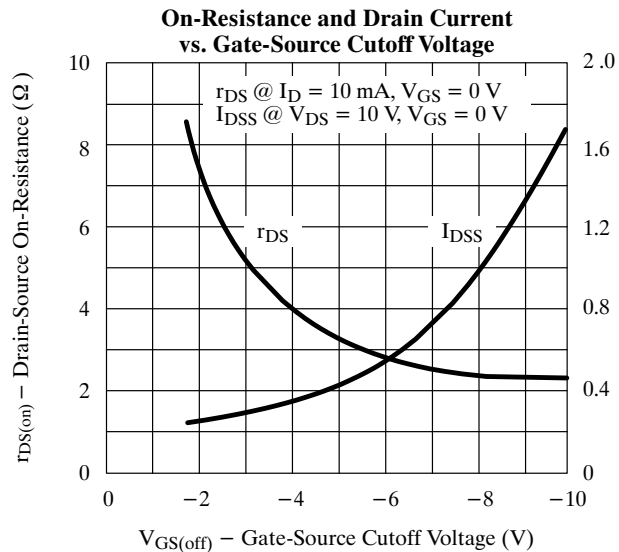

Typical Characteristics (Cont'd)

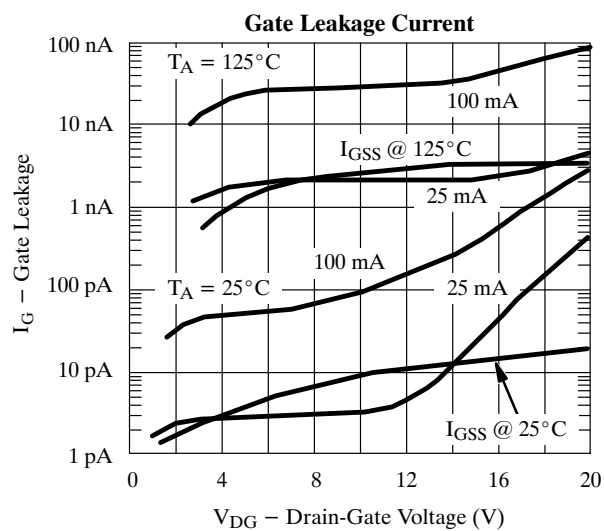
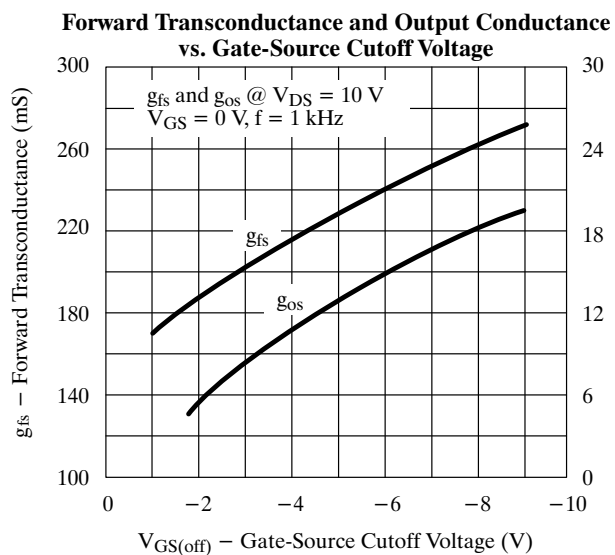
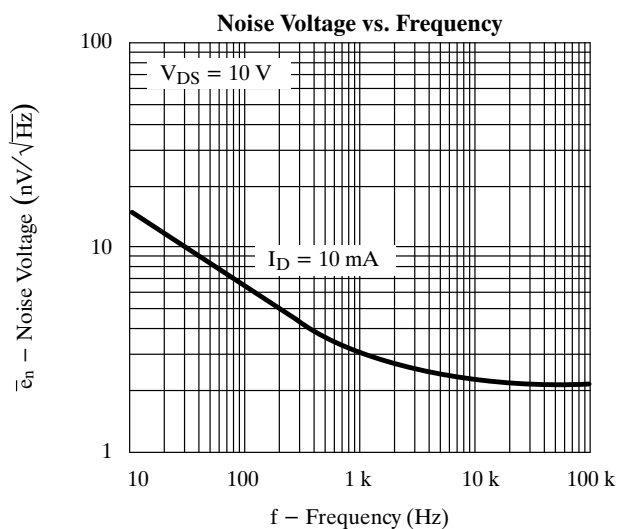
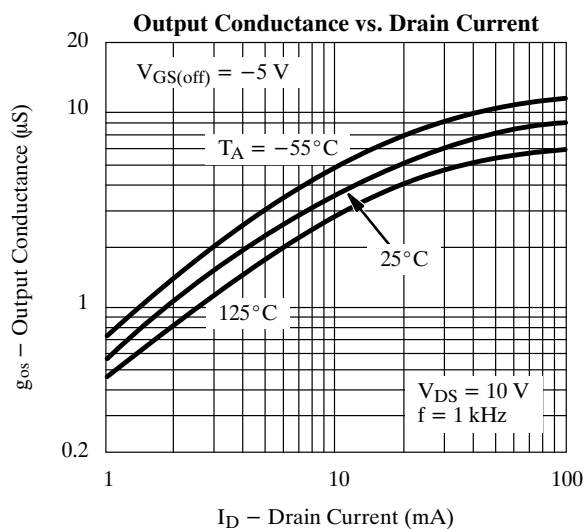
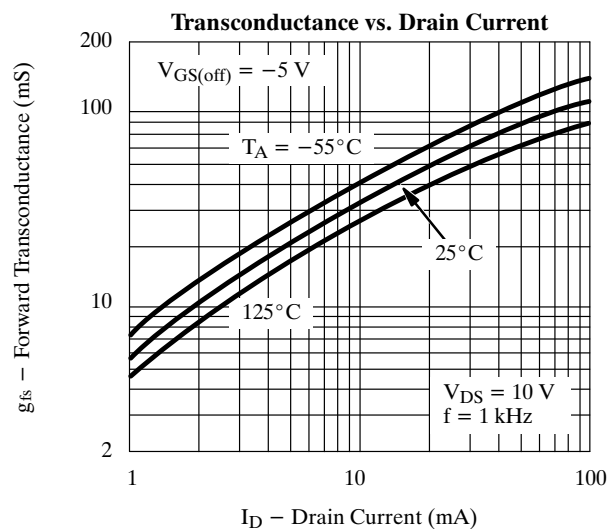
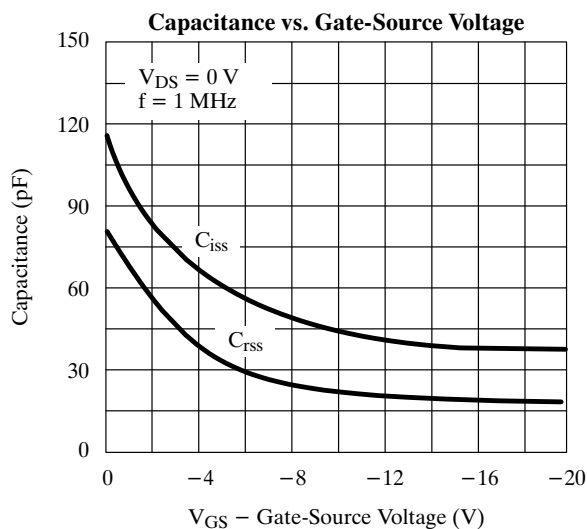

Typical Characteristics (Cont'd)

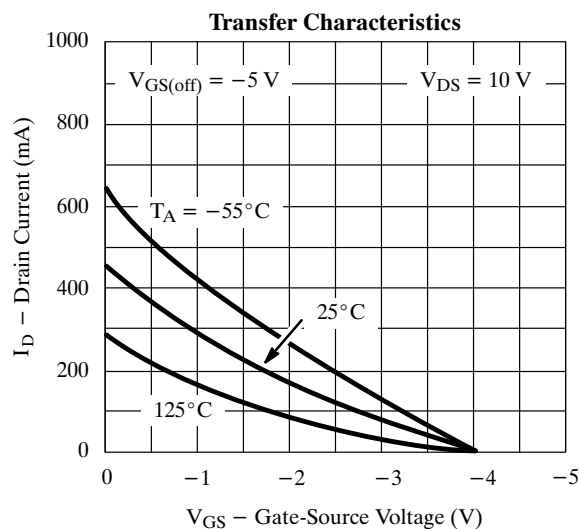
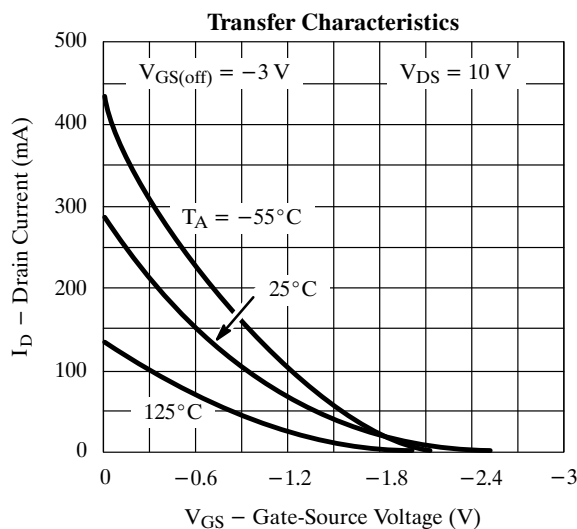
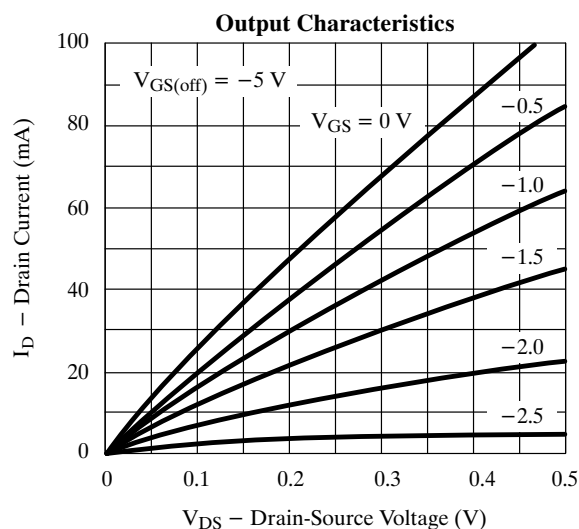
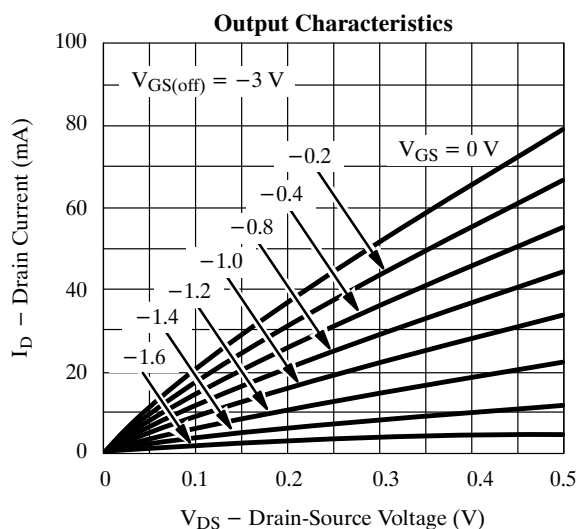

Switching Time Test Circuit

	U290	U291
V_{DD}	1.5 V	1.5 V
R_L^*	50 Ω	50 Ω
$I_{D(on)}$	30 mA	30 mA
$V_{GS(L)}$	-12 V	-7 V

*Non-inductive

Input Pulse

Rise Time < 1 ns
 Fall Time < 1 ns
 Pulse Width 100 ns
 PRF 1 MHz

Sampling Scope

Rise Time 0.4 ns
 Input Resistance 10 M Ω
 Input Capacitance 1.5 pF

See Typical Characteristics curves for changes.

